



# Soul kit

Instructions manual

---

G2+ 2 wire installation  
Art 7W monitor  
with Wi-Fi connectivity



Cód. 50122126

TS5110 ART 7W ES REV.0119

---

**INDEX**

Index.....	2
Recommendations.....	3
System operation.....	3
FA-G2+ power supply.....	4
Description.....	4
Installation.....	4
Soul door panel.....	5 to 8
Description.....	5
Installation.....	6
Wiring connectors.....	6
Configuration switches.....	7
Audio level adjustment.....	7
Proximity reader programming.....	8
Art 7W/G2+ monitor.....	9 to 21
Description.....	9
Installation.....	10
Wiring connectors.....	10
Configuration switches.....	10
Main menu.....	11
Settings menu.....	12 to 15
Communication screen.....	16
Picture and communication adjustments.....	17
Intercom menu.....	18 to 19
Recordings menu.....	20 to 21
G2Callapp.....	22 to 29
Initial registration of a monitor to a Wi-Fi network.....	22 to 23
Registration of an already network connected monitor.....	24
Advanced settings of a registered monitor.....	25 to 26
Main screen.....	27
Communication screen.....	28 to 29
Installation diagrams.....	30 to 34
Wiring sections and distances.....	30
One apartment with one access door and one monitor.....	30
One apartment with two access doors and one monitor.....	30
One apartment with two access doors and up to four monitors daisy chain connected.....	31
One apartment with two access doors and four monitors through video distributor.....	31
Four apartments with two access doors and up to four monitors daisy chain connected.....	32
Lock release connection.....	33
Relay output auxiliary device connection.....	33
Exit button connection.....	34
External CCTV camera connection.....	34
Door bell push button connection.....	34
Special codes.....	35 to 36
Soul door panel installation template.....	37
Art 7 monitor installation template.....	38
Notes.....	39

---

---

## RECOMMENDATIONS

---

- Use, preferably, Golmar **RAP-GTWIN / HF** cable (2x1mm<sup>2</sup>).
- Installation wires must be at least **40cm away of any other installation**.
- When modifications are made to the installation, **do so without power**.
- The installation and handling of this equipment must be carried out by **authorized personnel**.
- Check all connections before system start up.
- Follow the instructions in this manual at all times.

## SYSTEM OPERATION



---

To make the call, the visitor must press the corresponding button to the apartment with which he wishes to establish communication; an acoustic tone will warn that the call is being made and the  led will light up. At that moment, the monitor (s) of the apartment receives the call. If the pushbutton of another apartment has been pressed by mistake, press on the one that corresponds to the desired apartment, thus canceling the first call.

In systems with two access doors, the other door panel will be automatically disconnected: if another visitor wishes to call, some acoustic tones will warn that the system is busy and the  led will light up.

Upon receiving the call, the image will appear on the main monitor screen (and secondary 1, if any) without the visitor perceiving it. If you want to view the image from the secondary monitors 2 or 3, click on the screen to display the image. If the call is not answered within 30 seconds, the  led will turn off and the system will be free.

If the call transfer was programmed to your mobile phone, you can cancel the transfer at any time from the monitor, being necessary to contact the door panel from the main menu.

To establish communication, click on the screen on the off-hook icon. The  led on the door panel will light up. The communication will last for 90 seconds or until you click on the hanging icon. Once the communication is complete, the  led will turn off and the system will be free.

To open the door or activate the auxiliary output of the door panel, click on the corresponding icon. A single press activates the lock release or the auxiliary output for 3 seconds, and the  led on the door panel illuminates. The activation time is programmable, as indicated on pages 35 to 36.

The detailed operation of the monitor is described on pages 11 to 21.

The owner of the apartment can activate the lock release by approaching the proximity key to the reader. If the proximity key is maintained for three seconds, the auxiliary relay output will be activated.

---

FA-G2+ POWER SUPPLY

Description

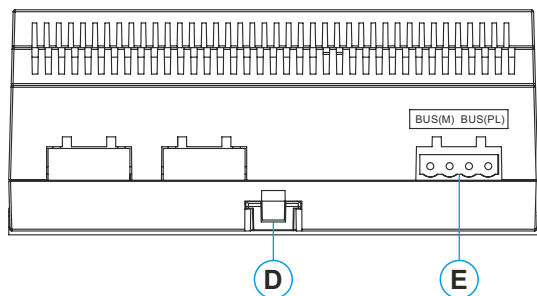
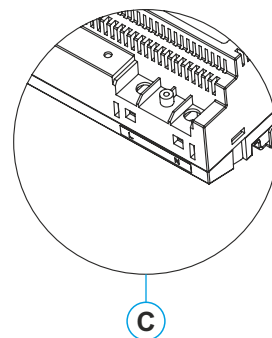
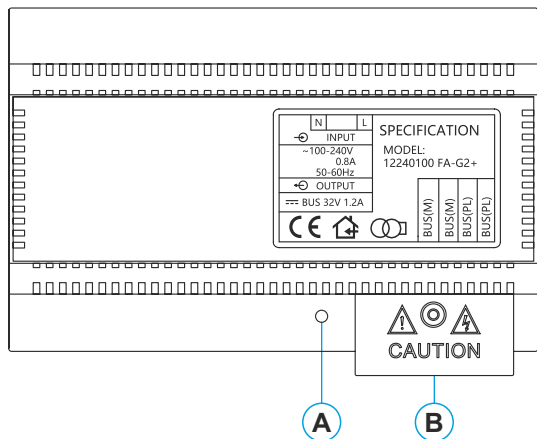

- A. Operating light indicator.
- B. Mains protection cover.
- C. Mains input terminals without protection cover.
- D. DIN rail fixing clip.
- E. Wiring connectors.

Installation

The installation and manipulation of the power supply must be carried out by authorized personnel and in the absence of electric current.

Install the power supply in a dry, protected and ventilated place. Under no circumstances obstruct the ventilation grilles. Use a DIN 46277 guide for fastening (8 elements).

Remember that the current regulations require to protect the power supply with a circuit breaker.

To avoid electric shock, do not remove the protection cover without first disconnecting the power supply. Re-install it once all connections are complete.

Connect the cables to the wiring connectors following the indications of the installation diagrams.

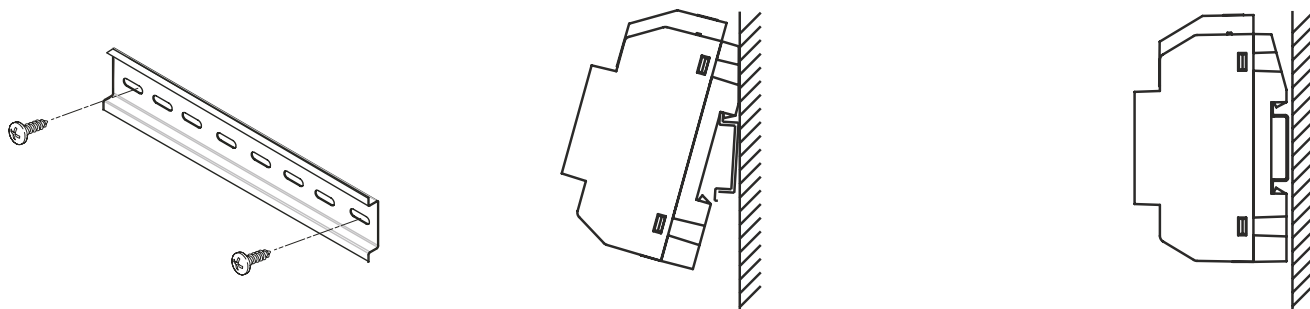

SOUL DOOR PANEL

Description

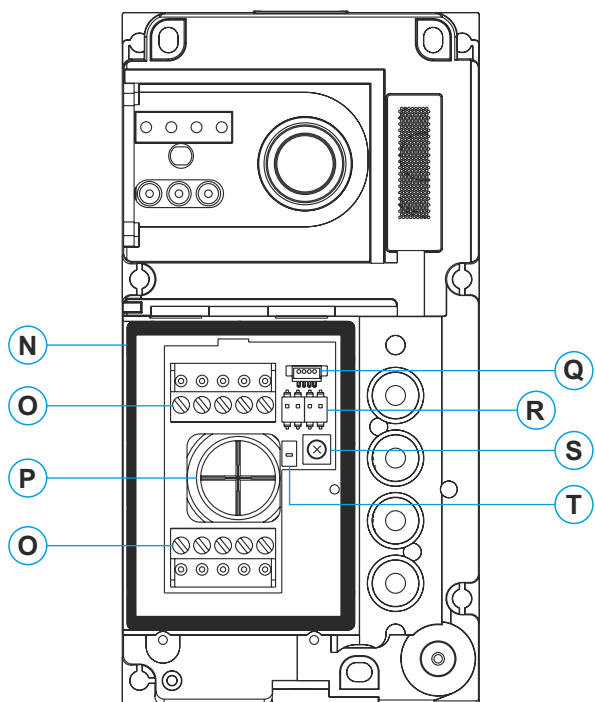
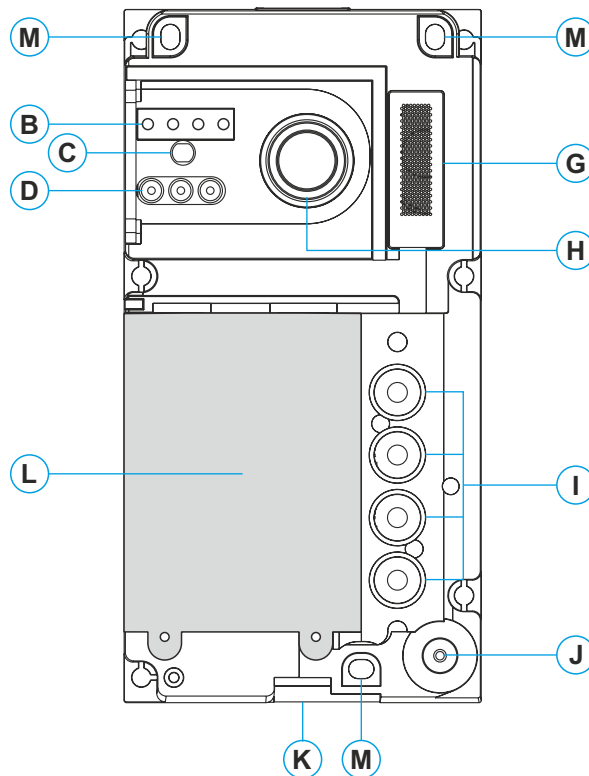
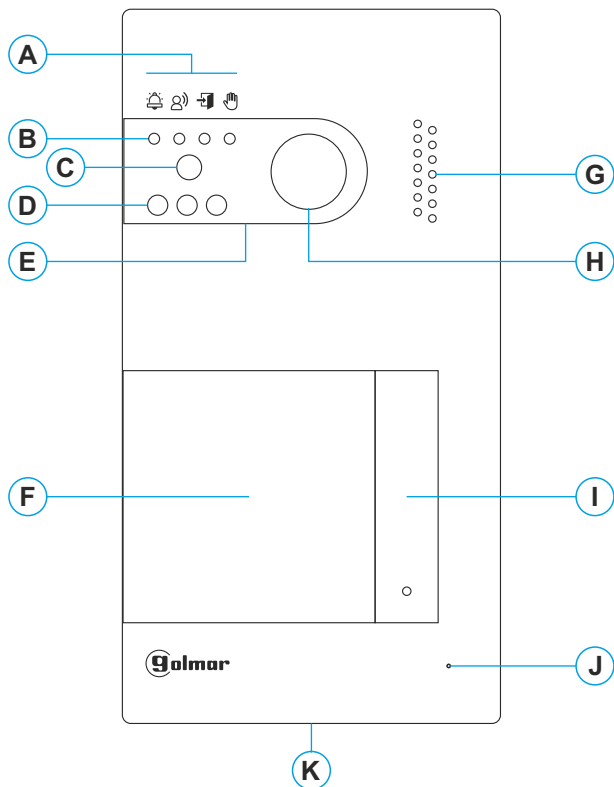

- A.** System status icons:
  - ☎ Call is in progress.
  - 🗉 In communication.
  - 🔓 Lock release activated.
  - 🚫 System is busy.
- B.** System status light indicators.
- C.** Light sensor.
- D.** Night vision illumination.
- E.** Protective polycarbonate.
- F.** Name holder and proximity reader.
- G.** Speaker grille.
- H.** Colour camera.
- I.** Push button (s).
- J.** Microphone hole.
- K.** Fixing screw.
- L.** Proximity reader.
- M.** Wall fixing holes (x3).
- N.** Proximity reader sealing gasket.
- O.** Wiring connectors.
- P.** Cable gland seal.
- Q.** Proximity reader connector.
- R.** Configuration switches.
- S.** Audio level potentiometer.
- T.** Proximity reader configuration push button.

## SOUL DOOR PANEL

### Installation

The door panel has been designed to withstand various environmental conditions. However, we recommend taking additional precautions to extend its life, such as to place it in a protected place.

To obtain optimum image quality, avoid backlighting caused by light sources (sun, lampposts, ...).

For a correct installation, use the supplied template (page 37).

1. Locate the top of the template at a height of 1.65m, and make three 6mm holes at the indicated points. Insert the supplied plugs.
2. Remove the metal front of the door panel by loosening the screw on the bottom with the key that is attached. On the back of the front you will find the name holder label.
3. Remove the screws that hold the proximity reader and pass the installation cables through the cable gland seal.
4. Fix the door panel to the wall using the screws provided.
5. Connect the cables to the removable wiring connectors following the indications of the installation diagrams.

Before replacing the proximity reader and closing the door panel, make the necessary adjustments (programming of proximity keys, adjusting the audio level, ...), as indicated throughout this manual. Make sure that the sealing gasket of the proximity reader is correctly positioned.

### Wiring connectors (O)

For a more comfortable installation, the wiring connectors are removable and are supplied in a separate bag. Once the connectors are wired, place them in their position.

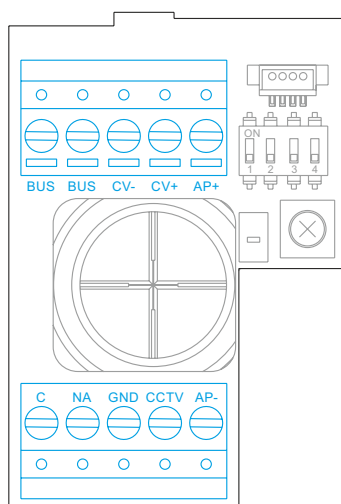

BUS, BUS: communication bus (polarity free).

CV-, CV+: 12Vd.c. lock release output (270mA maximum).

AP+, AP-: remote activation push button input.

C, NA: voltage free relay output (6A/24V maximum).

GND, CCTV: external analog CCTV camera input.

SOUL DOOR PANEL

Configuration switches (R)

Configuration changes must be made with the equipment switched off. If they are carried out with the equipment on, disconnect it for 10 seconds after any modification.

All switches are factory-set to the OFF position.

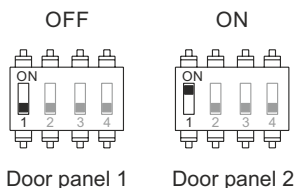

**Switch 1.**  
Sets the door panel address.

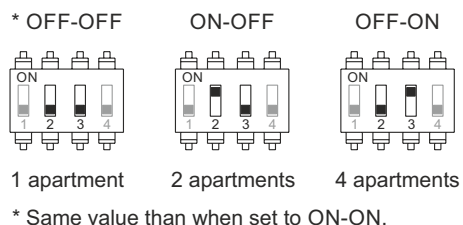

**Switches 2 and 3.**  
Set the number of apartments:  
1: all push buttons call to apartment n.1.  
2: the two lower push buttons call to apartment n.1, the two upper push buttons call to apartment n.2.  
4: each push button calls to a different apartment (n.1 to 4).

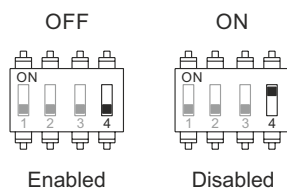

**Switch 4.**  
Disables door panel acoustic tones.

Audio level adjustment

If after the start-up of the system you consider that the audio volume on the door panel is not suitable, use the adjustment potentiometer (S). This regulation affects the audio level of the communication and that of the confirmation tones.

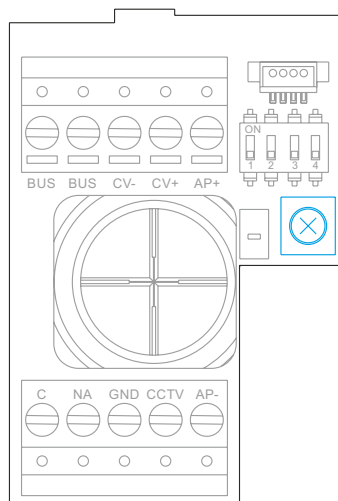







**ART 7W/G2+ MONITOR**

**Installation**

Avoid locations near heat sources, dusty or with a lot of smoke.

For a correct installation, use the supplied template (page 38).

1. Locate the top of the template at a height of 1.65m.
2. If you are going to use an embedding box to pass the cables, match it with the holes corresponding to the chosen box model and fix the bracket. If you prefer to fix the bracket directly on the wall, make four 6mm holes at the indicated points; insert the supplied plugs and screw the bracket.
3. Pass the installation cables through the central hole and connect them to the removable wiring connectors following the indications of the installation diagrams. Before connecting the wiring connectors to the monitor, set the configuration switch as indicated below.
4. Connect the wiring connectors to the monitor and place the monitor front to the bracket, matching the slots. Move the monitor down to fix it.

**Wiring connectors (K)**

For a more comfortable installation, the wiring connectors are removable and are supplied in a separate bag. Once the connectors are wired, place them in their position.

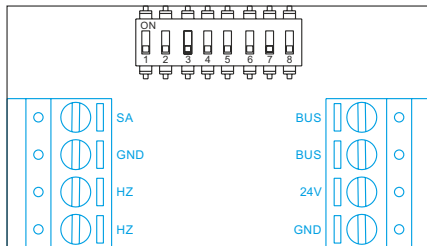

BUS, BUS: communication bus (polarity free).  
 24V, GND: local power supply input.  
 SA, GND: ringer output (50mA/12V maximum).  
 HZ, HZ: doorbell push button input.

**Configuration switches (R)**

**Switches 1 to 5.**

Assign the monitor address corresponding to its push button on the door panel. Switches 3 to 5 must remain in the OFF position.

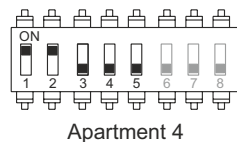
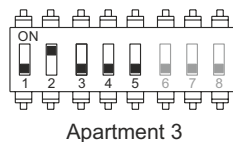
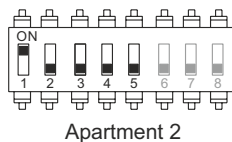

**Switches 6 and 7.**

They define if the monitor is master or secondary. Each apartment must have a master monitor only. In the case of apartments with more than one monitor, the monitor with WiFi transmitter should always be the master one.

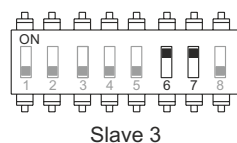
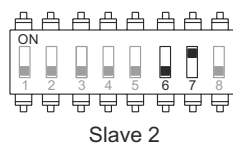
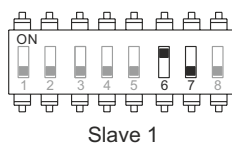
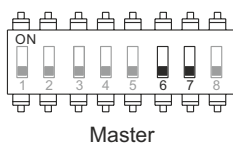

**Switch 8.**

Loads the monitor with the end of line resistor when set to ON. Activate it on those monitors where the bus cable path ends. Deactivate it only in the intermediate monitors.

## ART 7W/G2+ MONITOR

## Main menu

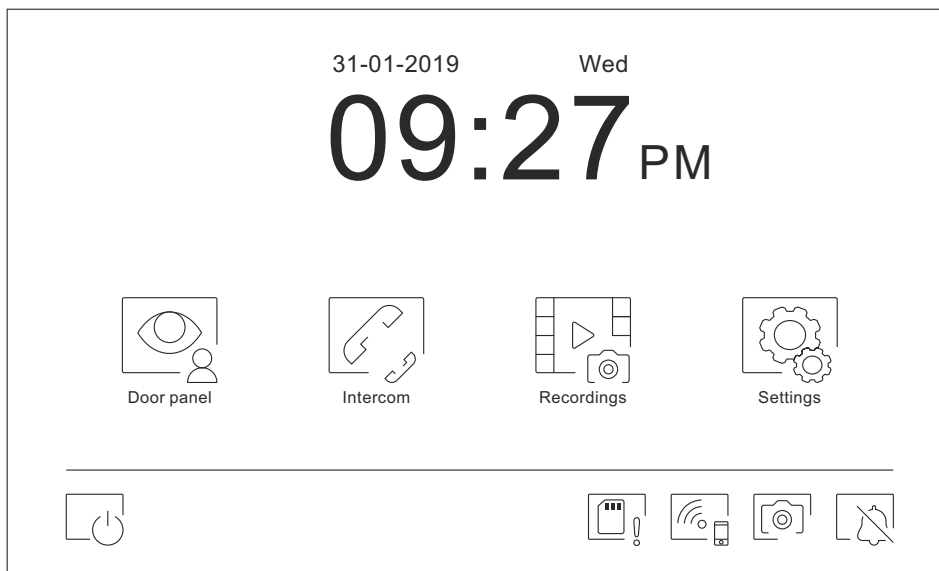

If the monitor is on standby mode (screen off), touch anywhere on the screen to activate it and the main menu will appear. The monitor will return to the standby mode after 1 minute without activity.



It allows to see the image coming from the door panels and cameras connected to the system



It access to the intercom menu with other system monitors.



Displays the list of images recorded in the monitor's memory. If there are new images or some are not yet displayed, the quantity will be shown in the upper right part of the icon. If the amount is greater than 9, three points will be shown.

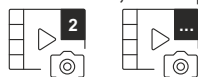

Allows to change system settings.



Switches off the monitor screen. Apaga la pantalla del monitor.



Indicates that the inserted micro SD card must be formatted from the monitor. Press to access the storage menu and format the card.



Press to enable or disable Wi-Fi transmission. The icon will change color (enabled white, disabled off) and the notification icon will light depending on the status.

**Only the master monitor can activate the Wi-Fi transmission.**



Changes the image recording mode during the reception of the call: no recording, snapshot picture or video. Video mode is only available when a micro SD card is inserted.



Press to enable or disable the "Do not disturb" function (the monitor does not ring when a call is received). The notification icon will light depending on the status.

## ART 7W/G2+ MONITOR

## Settings menu

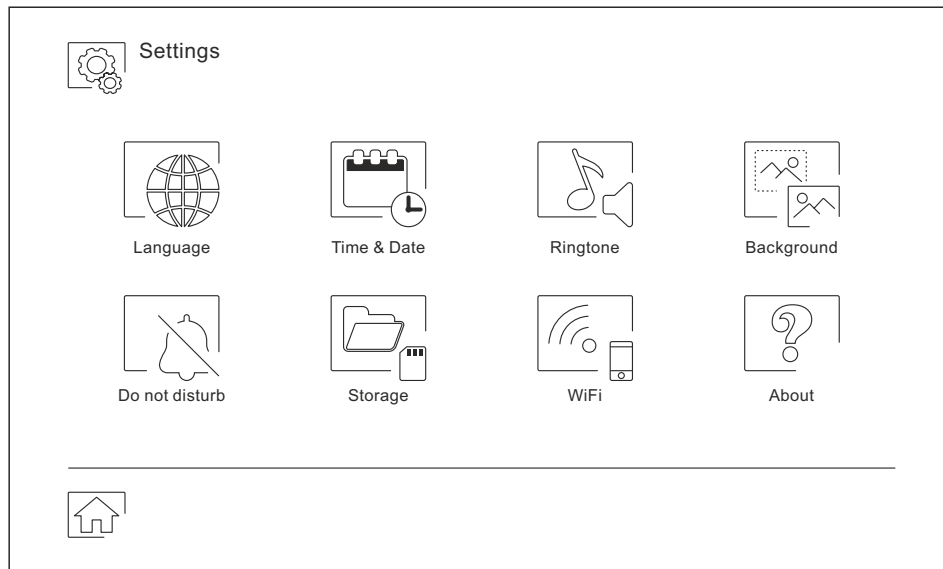

Use  icon to return to the main menu.



It allows you to choose one of the 16 available languages for the user interface. Once chosen, confirm your selection with the  icon, returning the monitor to the settings menu.

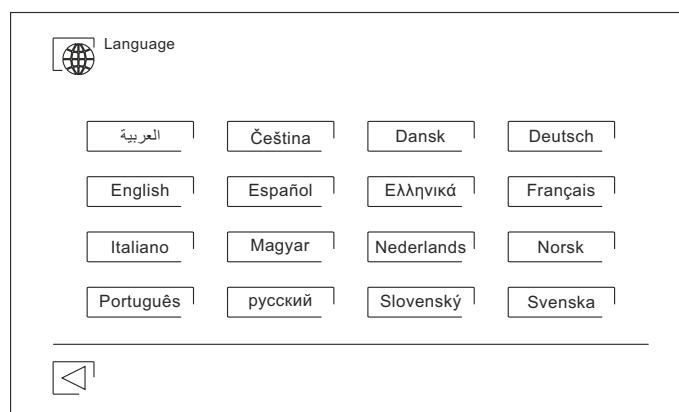



ART 7W/G2+ MONITOR

Settings menu

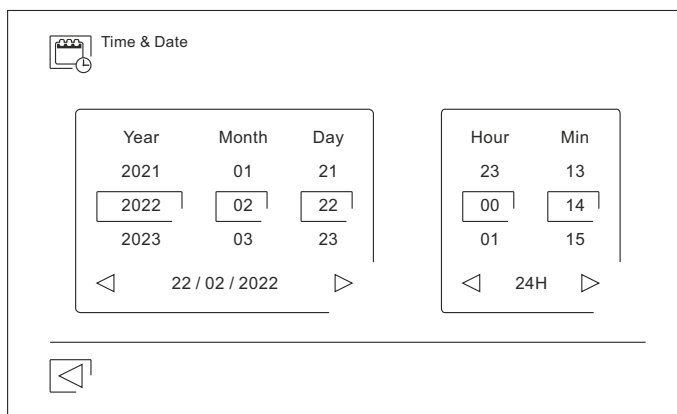

It allows to adjust the date and time of the system, as well as the presentation format. Change the values by sliding up or down, and use the arrows to change the formats. Validate the changes made with the  icon, returning the monitor to the settings menu.



In order to distinguish the origin of the calls when you are not in front of the monitor, choose different melodies using the arrows. Once chosen, confirm your selection with the  icon.

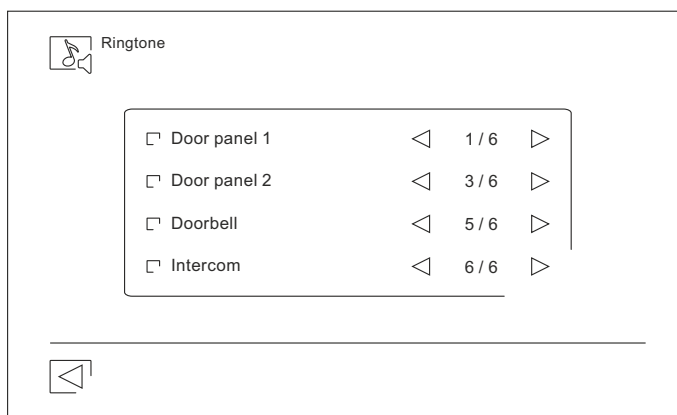

Personalize the monitor with one of the six available coloured backgrounds. Select your favorite and validate the changes made with the icon , returning the monitor to the settings menu.

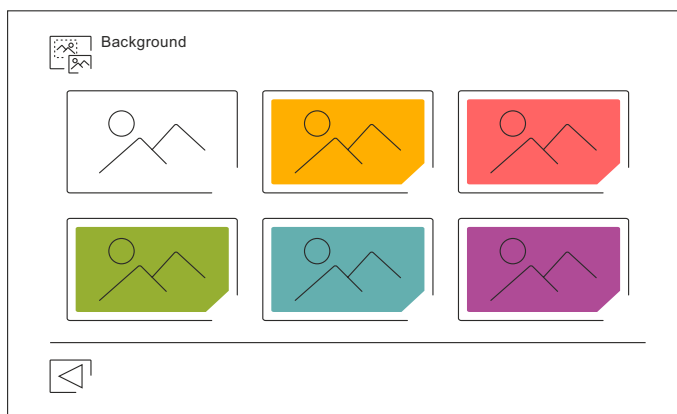

## ART 7W/G2+ MONITOR

## Settings menu



In the "Do Not Disturb" settings you can set a time period in which the monitor will not ring when receiving calls. To do this, activate the timer function and choose the time period. From the main menu you can activate and deactivate the "Do not disturb" function regardless of the timer status.

If you do not want to be contacted from another monitor, you can deactivate the intercom function. If you do, you can not contact other monitors either.

Validate the changes made with the icon , returning the monitor to the settings menu.

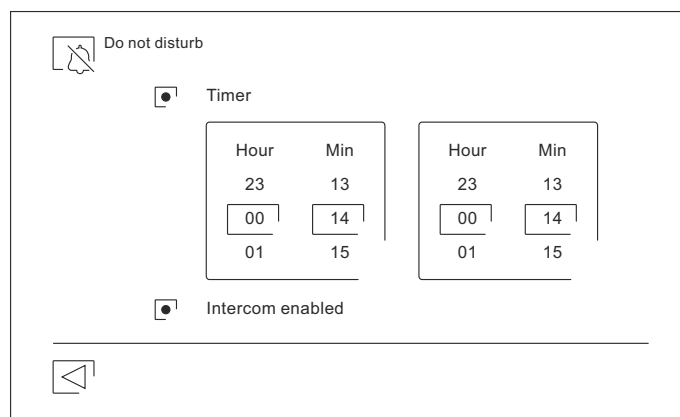

In some countries, the law does not allow the storage of images or videos for more than 30 days after recording. The automatic erase function performs this task for you. You can deactivate this function in the case of the legislation of your country does not demand it, or under your responsibility.

If you have not inserted a micro SD card into the monitor, only snapshot pictures can be recorded in the monitor's internal memory (up to 100). If you have inserted one, the images and videos will always be recorded on the card, and the images in the internal memory can not be displayed until you copy them on the card.

From this menu you can delete the contents, copy the internal memory to the SD card and format the card. Any of these actions will require your confirmation.

Use  icon to return to the settings menu.

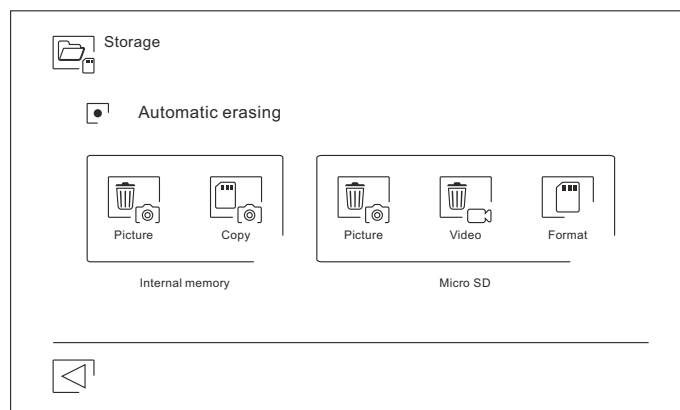

## ART 7W/G2+ MONITOR

## Settings menu



During the first system start-up, we recommend to restart the Wi-Fi parameters using the icon.

Remember that **only the master monitor can activate the Wi-Fi transmission.**

The Wi-Fi menu shows information about the identity of the monitor (UID), the name of the network to which it is connected (SSID) and the signal strength. Use G2Call application to connect the monitor to your Wi-Fi network as detailed below.

Choose, using the arrows, the time you want to elapse between the reception of the call from the door panel and the start of the transfer of the call to the mobile phone. Validate the changes made with the icon , returning the monitor to the settings menu.

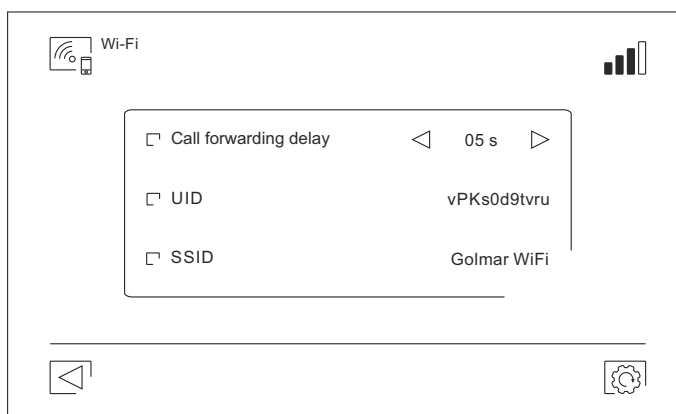

The "About" screen provides information about the equipment, such as the monitor version and its address.

Click on the icons to display the QR code that will take you to the updated downloads of this instruction manual and the G2Call application for your mobile phone.

Use the icon to restore factory settings, such as language, melodies, ... The Wi-Fi parameters will not be modified.

Use the icon to return to the settings menu.

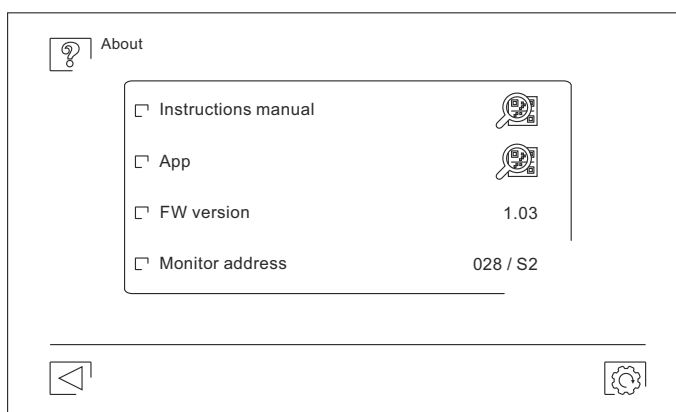

## ART 7W/G2+ MONITOR

## Communication screen

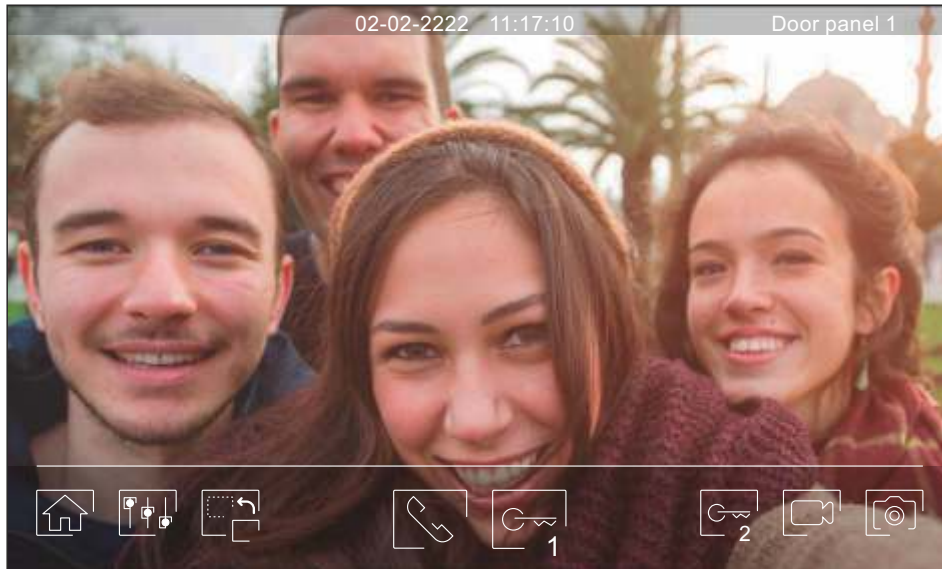

This screen is displayed when you receive a call or when you press  icon from the main menu. The date and time are shown in the top center of the screen, and the source of the image (door panel 1, door panel 2, camera 1 or camera 2) is shown on the right. After 10 seconds without activity, the icons will disappear; tap anywhere on the screen to reappear.



Cancels the call or display in progress and returns to the main menu.



Access to the picture and communication settings menu.



Change the image source, as long as the system has more than one door panel or has an external camera connected and their visualization has been activated (see page 35). It is possible to change the image source at any time.



Starts or ends audio communication with the displayed door panel. The communication has a maximum duration of 90 seconds. Once the communication is finished, the screen will turn off.



Activates the lock release (or device connected to the CV output of the door panel) for 3 seconds (factory value, programmable by the installer). During activation, the  notification icon will light.



Activates the lock release (or device connected to the relay output of the door panel) for 3 seconds (factory value, programmable by the installer). During activation, the  notification icon will light.



In case of having a micro SD card inserted, starts recording a video of 15 seconds. Otherwise, it will take a snapshot picture. The  notification icon will light.



Takes a snapshot picture. The  notification icon will light.



## ART 7W/G2+ MONITOR

## Picture and communication adjustments

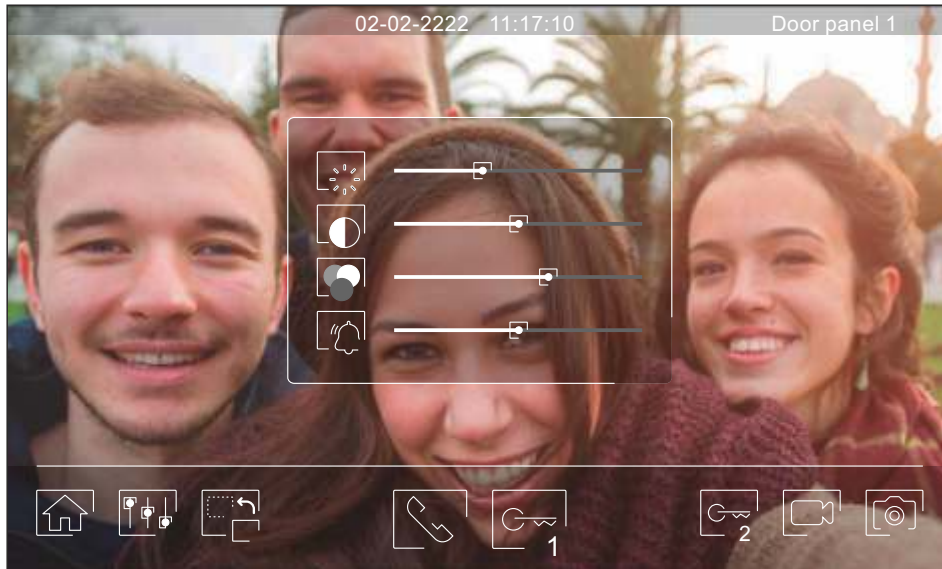

During the visualization or communication process, it is possible to adjust the parameters of the image (brightness, contrast and color), the volume of the ringing tone (during visualization) and the audio level of the speaker (during communication).

Press the  icon and use the sliders to make the adjustments. Clicking on the icon again, the settings window will disappear.

## ART 7W/G2+ MONITOR

### Intercom menu

From this menu you can communicate with other monitors of your apartment (internal intercom) or your building (external intercom). To do this, your monitor and the called one must have activated the intercom function from the "Do not disturb" menu.

Use  and  icons to switch between internal and external intercom screens.

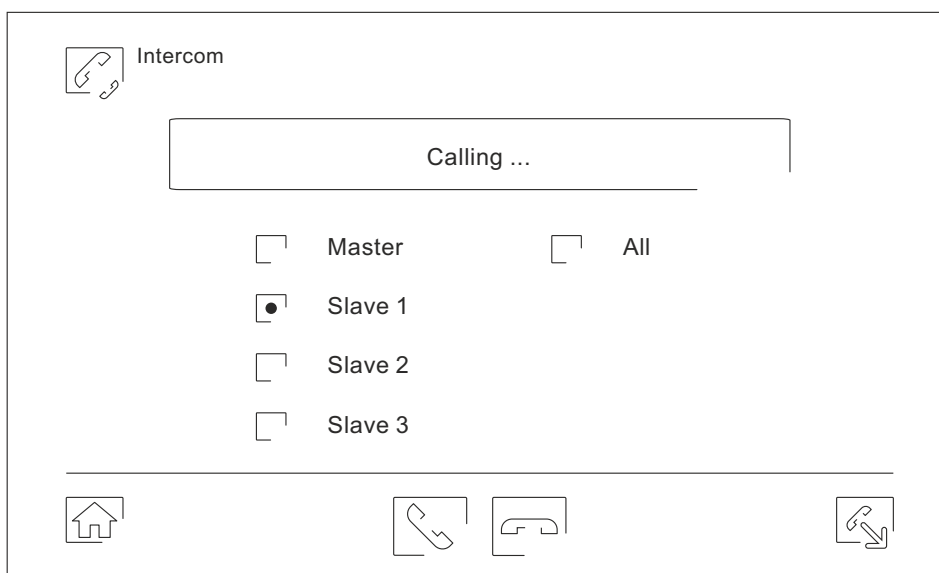

If during the intercom process with another monitor a call is received from the door panel, the intercom process will be terminated, and the call from the door panel will be received on the corresponding monitor.

Use  icon to return to the main menu.



### Internal intercom.

Select the monitor with which you want to communicate. The monitor that appears selected by default it's yours. You will find information about the monitor's address in the "About" menu. If you select the "All" option, the rest of the monitors will receive the call, establishing communication with the first one that responds.

To make the call, press on the  icon, the message "Calling ..." appears on the screen. The monitor or monitors that receive the call will display the message "Calling from", followed by the calling monitor address. To cancel the call press on the  icon, appearing the message "Call finished".

---

**ART 7W/G2+ MONITOR**



---

**Intercom menu**

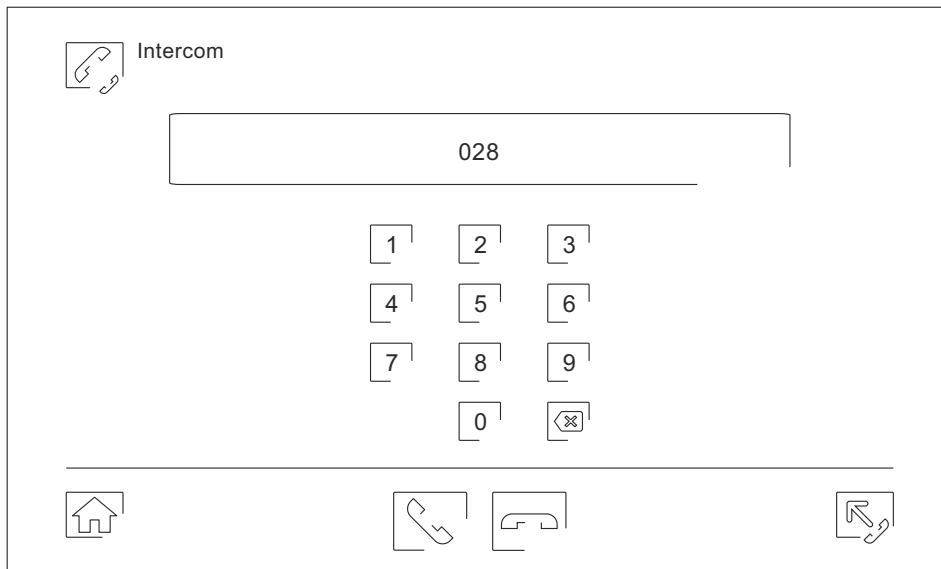
---



**External intercom.**

Enter the code of the apartment with which you wish to communicate using the keypad.

To make the call, press on the  icon, the message "Calling ..." appears on the screen. The main monitor of the called apartment will show the message "Calling from", followed by the calling monitor address. To cancel the call press on the  icon, appearing the message "Call finished".

ART 7W/G2+ MONITOR



Recordings menu

Displays the list of pictures saved on the monitor or on the SD card, if installed. The  icon allows us to access the video recordings stored on the SD card, and can return to the list of images using the  icon. The number of recordings per page is 10, showing the number of pages at the top of the screen. Use the scroll arrows to access the rest of the pages.

The  symbol indicates that the recording has not been displayed.

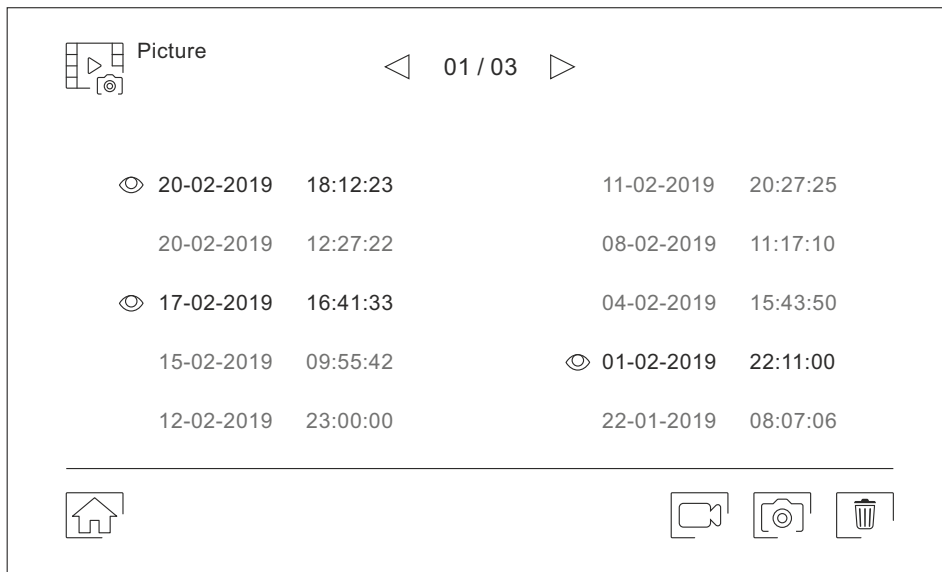
Use  icon to return to the main menu.



To delete one or more recordings from the list, use the  icon. Click on the recordings you want to delete or use the  icon to select them all. Confirm your selection using the  icon: a warning screen will ask for your final confirmation.

Use  icon to return to the recordings list.

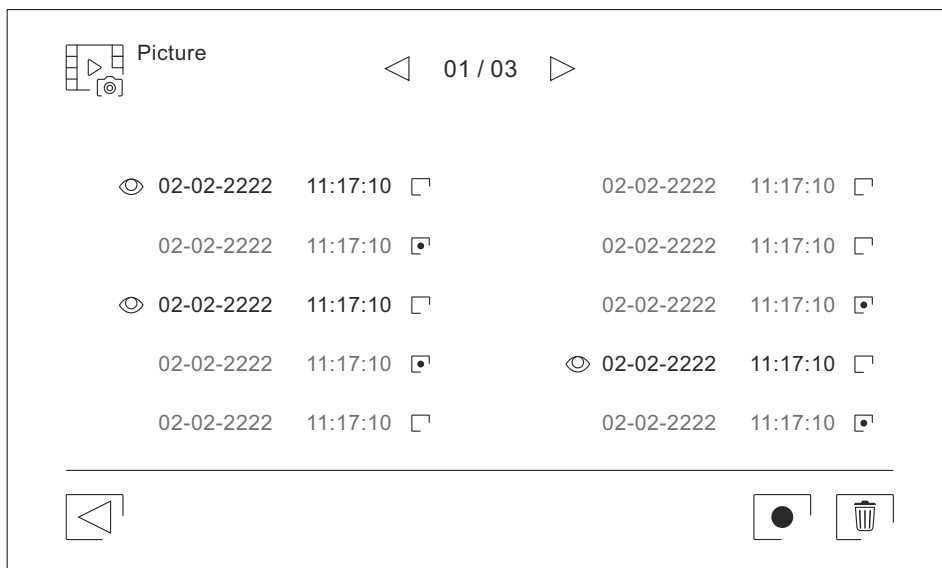

## ART 7W/G2+ MONITOR

### Recordings menu

To view a recording, click on it in the list. The recording will be displayed in full screen. Use the scroll arrows to show the next (▶) or previous (◀) recording. From this screen you can also delete the recordings individually, always requiring confirmation. Use the icon to play the pictures in sequence; if it is a video, the recording will start playing. Tap the screen to stop playback.

Use ◀ icon to return to the recordings list.



## G2Call APP

### Initial registration of a monitor to a Wi-Fi network

To register the monitor in the Wi-Fi network of your home, it will be necessary to download and install the G2Call application on your phone. The application is available for Android® and iOS™ operating systems and can be downloaded for free from Google Play and Apple Store respectively.



Start the application once installed on your phone. Read carefully the terms and conditions of use of the application: you can access it after accepting them. The application will request permission to access certain functions of the phone, such as the use of the loudspeaker, the microphone, ... You must give your authorization for the correct operation of the application.

During the registration process, some phones experience problems while they are connected to the mobile phone network. We recommend that you put your mobile in airplane mode, with Wi-Fi activated, during the registration process.

Activate the Wi-Fi functionality of the main monitor using the  icon from the main menu. Go to the Wi-Fi screen in the settings menu and check that the pairing signal  appears in the upper right part of the screen.

To start the registration, click on the "Add monitor" option. If there is already a monitor registered on your phone, click on the  icon to add a new monitor. Then click on the option "New monitor", since it is the first time the monitor is registered in the network of your home; if the monitor was previously registered in another network, restart the Wi-Fi settings as indicated on page 15. Leave the application screen in the background and activate the Wi-Fi of your phone; connect to the network that starts with "UID", return to the application screen and press "Next".

Select the Wi-Fi network to which you will connect your monitor. In case of more than one network, select the one closest to your monitor. **Note:** due to restrictions of the iOS operating system, it is not possible to display the list of available networks (see next page).

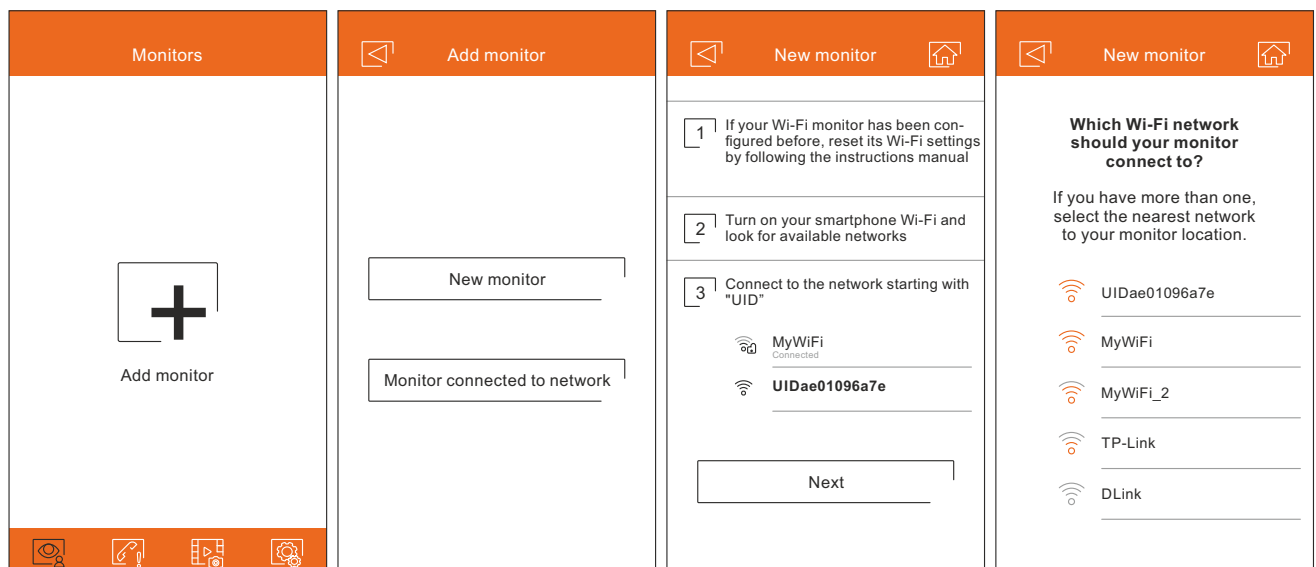

Android only screen

G2Call APP

Initial registration of a monitor to a Wi-Fi network

Enter the password for accessing the network. If you are registering on a device with an iOS operating system, manually enter the SSID identifier of the network. Pressing "Next" will start the pairing process, which can take up to two and a half minutes.

If the pairing process ends successfully, the basic monitor configuration screen will be displayed. Give it a name to differentiate it from other possible monitors registered on your phone. The factory default for the connection password is "1234." This password can only be changed once the monitor is registered. If the monitor is connected to a second door panel or CCTV cameras, indicate it.

If, on the contrary, the pairing process failed, go to the Wi-Fi screen of the monitor settings menu and verify that it's connected to your Wi-Fi network: the name of your network should appear in the SSID field and the upper right of the screen should show the intensity bars of the connection signal. In affirmative case, register the monitor with the option "Monitor connected to the network".

Once the process is finished, the registered monitor will appear as available.

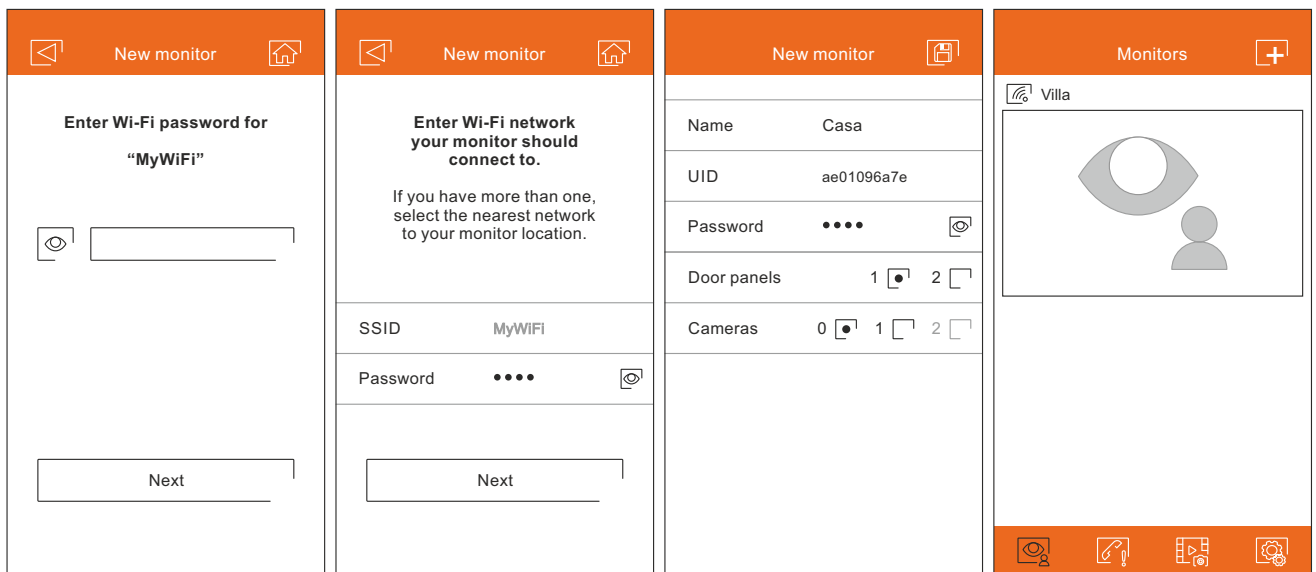

Android only screen

iOS only screen

## G2Call APP

## Registration of an already connected monitor

Make sure your phone has connectivity, either Wi-Fi or through your telephone network provider. Click on the "Add monitor" option or on the  icon to add a new monitor. Then click on the option "Monitor connected to the network". You can choose between searching for monitors connected to your network, being necessary the phone connected to it, or enter network data manually.

If you choose the "Search" option, the application will show you the identifiers (UID) of the connected monitors. Select the monitor you want to register in your application, showing the basic monitor configuration screen.

If you choose the "Add manually" option, you can scan the QR code located on the back of the monitor with your phone, or manually enter the UID (that can be found in the Wi-Fi screen of the settings menu) in the basic configuration screen of the monitor.

Once the process is finished, the registered monitor will appear as available.

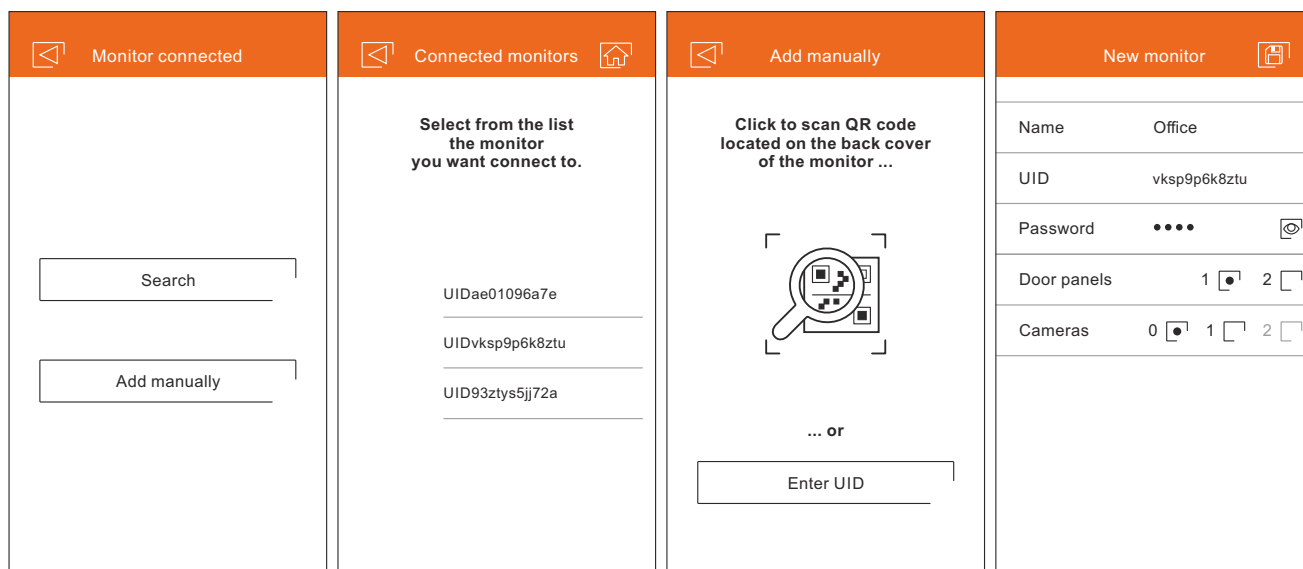





G2Call APP

Advanced settings of a registered monitor

To access the advanced settings of a monitor registered in the application, click on the preview screen of that monitor and then on the  icon on the top right of the screen. Even if the monitor is not connected at that moment, you can adjust the settings.

**ID.**

To make changes to the basic settings of the monitor, receiving notifications from the previous screen must be disabled. In addition to the basic monitor settings described on page 23, you can activate the password request function to open the door. This password is the same as that of the basic monitor settings, and can be changed from the advanced settings. This password will be requested to disable the function again.

Use  to change the settings. Once changes are made, save changes using  icon. If you want to discard changes made, use  icon.

**Password.**

It allows to change the connection password to the monitor. It is the same password used to open the door if the function has been activated. Once the password has been changed, save the changes using the  icon. If you want to discard changes made, use  icon.



















**Note:** this password is stored in the monitor. In case of that other phone has registered this monitor too, it will be necessary to apply the password change on the basic settings of this monitor too.

**Push to talk.**

The application has hands-free communication with the door panel. If you prefer, you can activate the "Push to talk" function by clicking on the box.

**Preview.**

Sets the quality of the video signal by default (number of images per second) to adapt it to the type of data connection. It also defines if the audio from the door panel to the phone is activated automatically upon receipt of the call, or on the contrary it is necessary to click on the pick-up icon.

 Monitor settings	 ID 	 Password 	 Preview
ID	Name Villa	Current 1 to 15 numbers	Audio 
Password	UID UID	New 1 to 15 numbers	Video Quality High 
Push to talk 	Password ●●●● 	Confirm 1 to 15 numbers	Mid 
Preview	PIN to unlock 		Low 
Wi-Fi	Door panels 1  2 		
Notification 	Cameras 0  1  2 		
FW version			
Time & Date synchronization			
Delete			

## G2Call APP

### Advanced settings of a registered monitor

#### Wi-Fi.

It allows you to change the Wi-Fi network to which the monitor is connected by another one available in your environment.

**Note:** due to restrictions of the iOS operating system, it is not possible to display the list of available networks, being necessary to manually enter the SSID identifier of the network.

Network change can only be done when the phone is in the same location as the monitor.

#### Notification.

To be able to receive call transfers from this monitor, it will be necessary to activate the notification function. Disable this function if all you want is to connect to the system without being called.

#### FW version.

It shows the FW version of this monitor and the latest version on the remote communications server, being possible to update it. The application informs of the availability of a FW version by means of a warning on the icon of advanced configuration of the monitor.

#### Date & Time synchronization.

It allows to update the date and time of the monitor with the data of the telephone.

#### Delete.

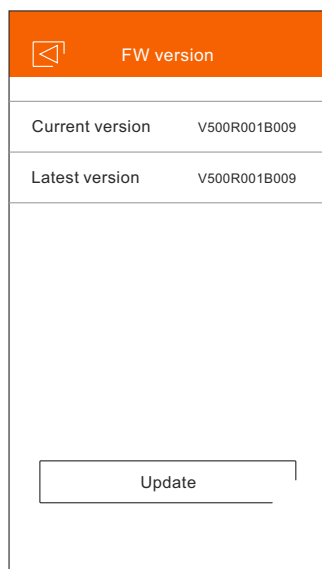

It deletes the monitor from the application. The reception of notifications must be disabled for deletion.











## G2Call APP

### Main screen

When running the application, and after the welcome screen, the selection screen of the connected monitors is displayed. Those that have connectivity will show the  icon. To visualize the image coming from one of the systems, press on the registered monitor, accessing the communication screen (see next page).

If you click on the  icon you will access the events screen. This screen shows the list of events: answered calls, missed calls and door openings. Each event shows the door panel number between parentheses and the time it occurred. Swipe the screen down to update the list. By clicking on the  icon you can delete the events that you select, or all simultaneously using the  icon.

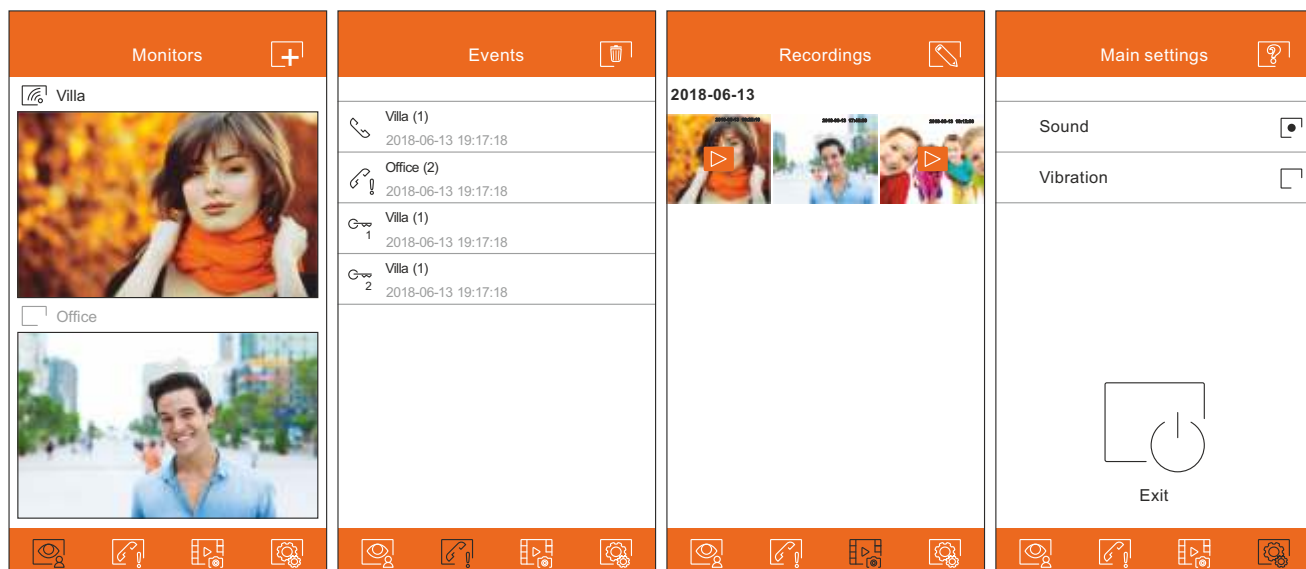

The  icon will take you to the screen that shows the snapshot pictures or videos recorded from the application. Click on any of the recordings to view it in full screen, from where you can also share or delete it individually. By clicking on the  icon you can delete and share several or all of the recordings simultaneously. To do this, use ,  and  icons.

To access the application settings press the  icon. From here you can select if you want the phone to ring and / or vibrate when you receive a call. By clicking on the  icon you can view the version of this application as well as Golmar's privacy policy. In the case of Android devices, exit the application using the  icon or force its closure: it will continue to receive calls and the application will not consume battery.



## G2Call APP

### Communication screen

If you have activated the call transfer on the monitor and the notifications are activated in the application, you will receive the calls made on the entrance panel. A pop-up screen will show you the origin of the call. You can accept the call through the  icon, or reject it by pressing . Once the call is accepted, you can establish audio communication by pressing the icon .

Whether you access the communication screen via a call reception or access from the main screen, the options detailed below will be the same.

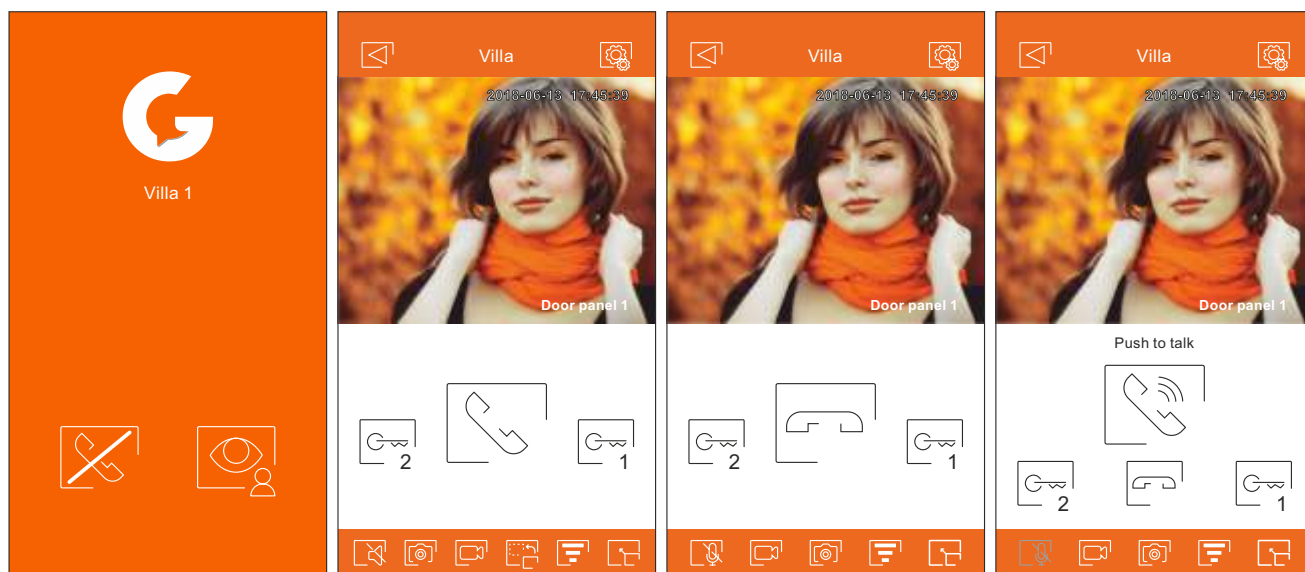

Enables or disables the audio coming from the door panel during the viewing process. The initial state depends on the monitor preview settings (page 25).

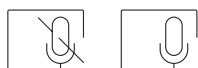

Activate or deactivate the phone's microphone during the communication process. In the communication mode "Push to talk" is deactivated.



Takes a snapshot picture.



Press to start recording a video. To end the recording, press the icon again.



Change the source of the image. This icon appears in case the system has more than one door panel or has an external camera connected, and has been configured in the basic settings of the monitor (pages 23 to 25). It is possible to change the source during the visualization and communication processes.



Start or end audio communication with the displayed door panel. The communication has a maximum duration of 90 seconds.



In the "Push to talk" communication mode, keep it pressed while talking and release to listen.

G2Call APP

Communication screen



Activates the door opener or device connected to the CV output of the displayed door panel or camera. It will be necessary to enter a password for activation if you defined it on page 25.



Activates the door opener or device connected to the relay output of the displayed door panel or camera. It will be necessary to enter a password for activation if you defined it on page 25.



It allows to change the quality of the video signal to adapt it to the type of data connection.



Switches between full screen mode (horizontal orientation of the phone) and normal screen mode (portrait orientation).

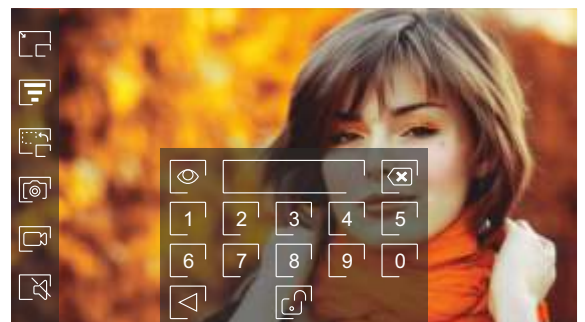
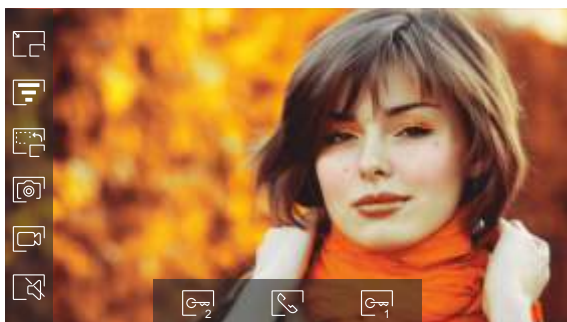

INSTALLATION DIAGRAMS

Wiring sections and distances

- The maximum number of monitors per apartment is 4.
- The maximum number of monitors connected in daisy chain configuration is 12.

Cable type	A	B	C
2 x 0,75mm <sup>2</sup> (AWG18)	30 m	30 m	15 m
CAT5	60 m	60 m	30 m
RAP-GTWIN/HF	60 m	60 m	30 m

- A. Distance between power supply and the farthest door panel.
- B. Distance between power supply and the farthest monitor (or video distributor).
- C. Distance between video distributor and the farthest monitor connected to one of its outputs.

One apartment with one access door and one monitor

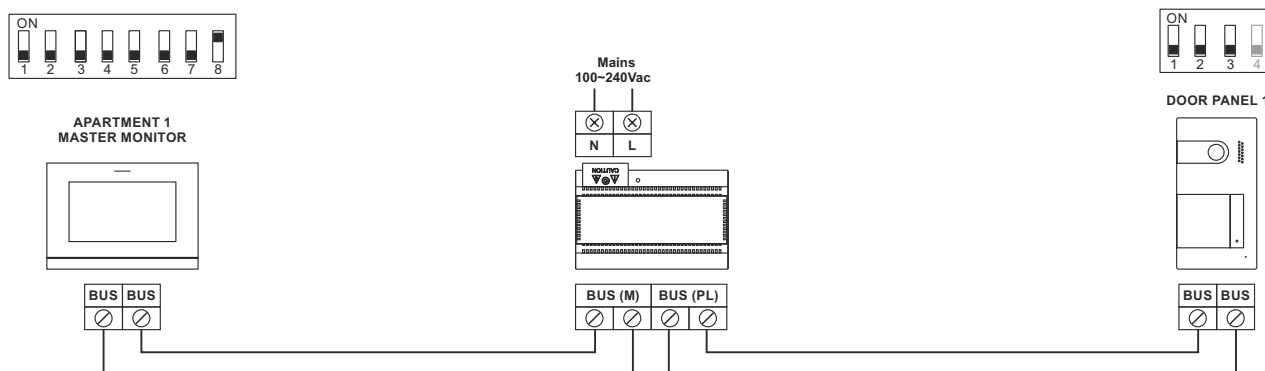

One apartment with two access doors and one monitor

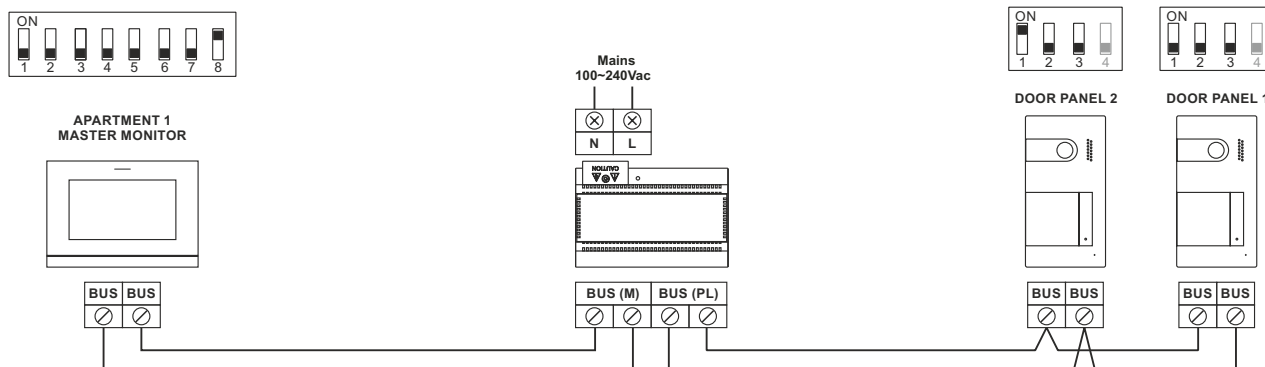

INSTALLATION DIAGRAMS

One apartment with two access doors and up to four monitors daisy chain connected

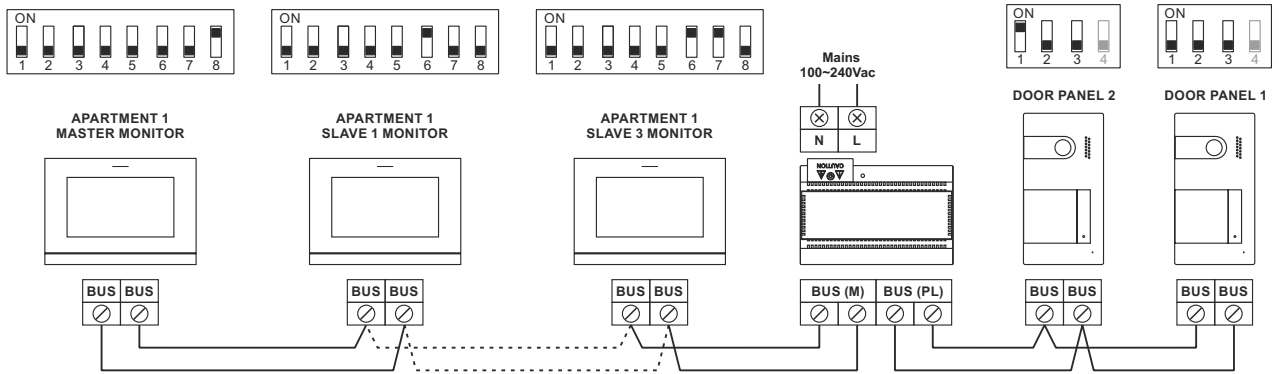

One apartment with two access doors and four monitors through video distributor

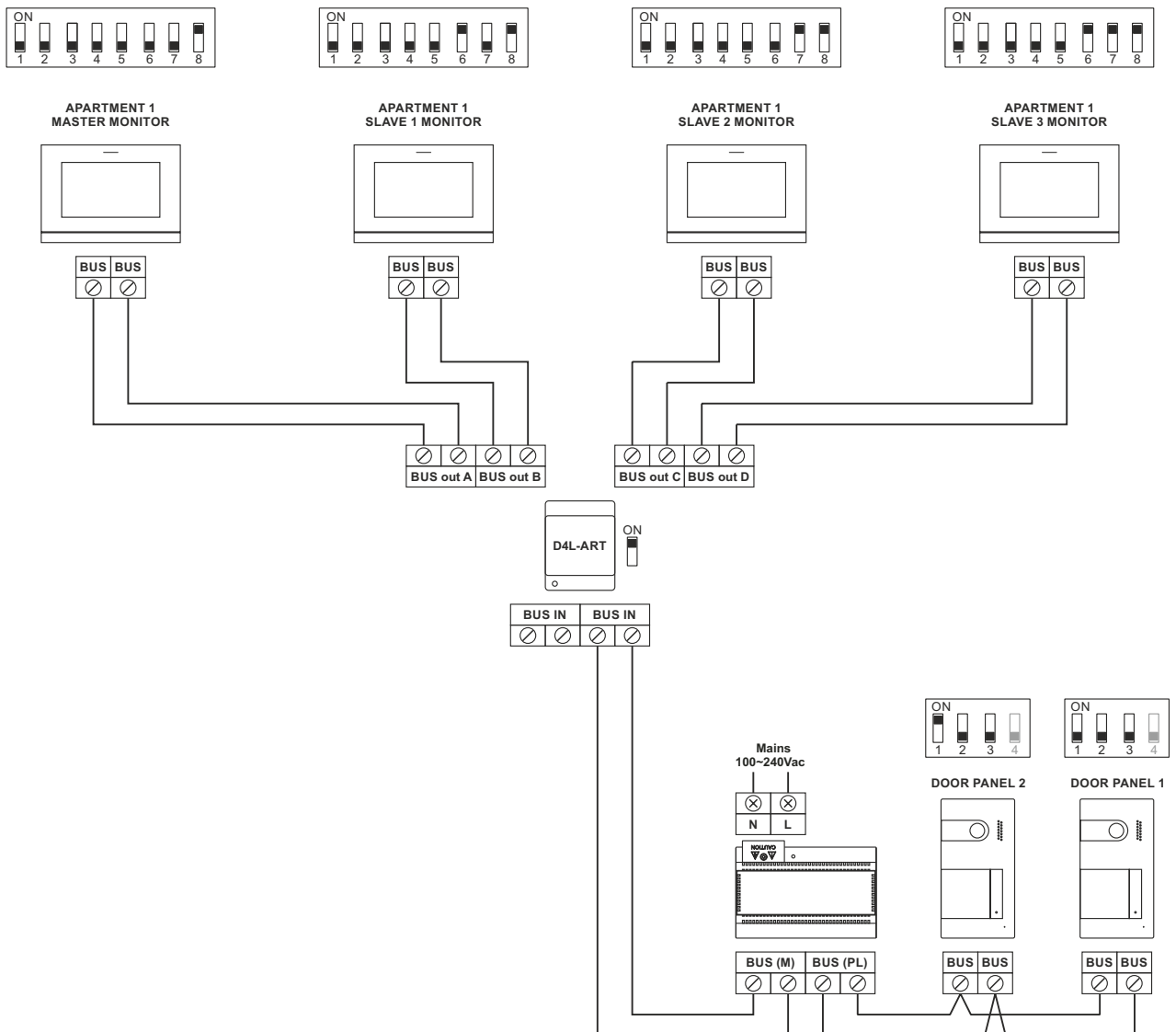

INSTALLATION DIAGRAMS

Four apartments with two access doors and up to four monitors daisy chain connected

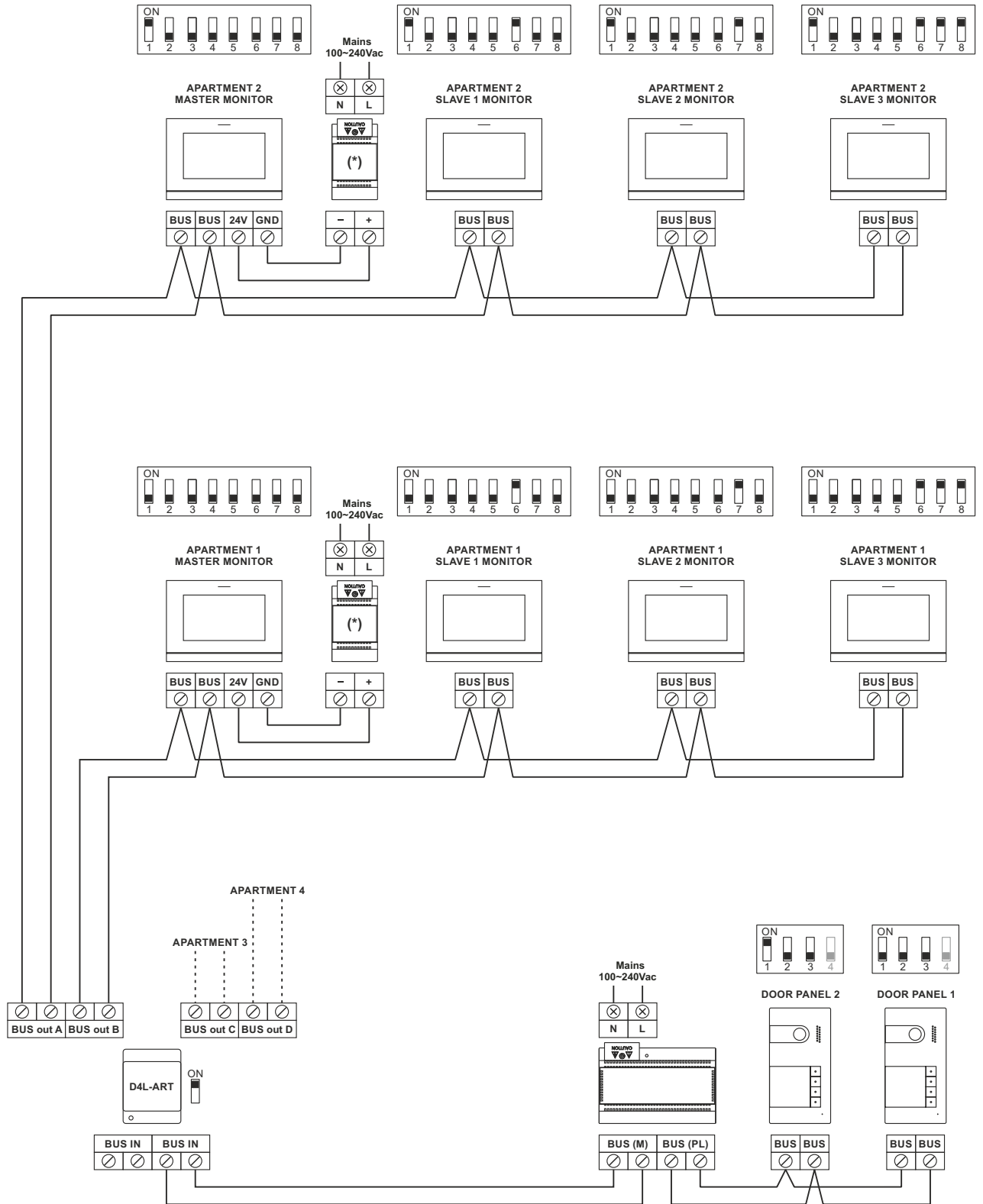

(\*) FA-ART 7W power supply



INSTALLATION DIAGRAMS

Lock release connection

The drawing shows the connection of a 12Vd.c. lock release, with a maximum consumption of 270mA. The use of the Golmar CV-14 / DC, CV-24 / DC, CV-14P / UNI or CV-24P / UNI models is recommended. Activation is done through the  icon.

The activation time is 3 seconds, it being possible to adjust it between 0.5 and 10 seconds (see page 36).

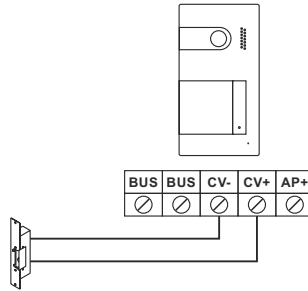

If the lock release you are going to use is AC, use a relay and a transformer suitable for consumption. The example shows a Golmar SAR-12/24 relay and a TF-104 transformer (12Va.c./1.5A).

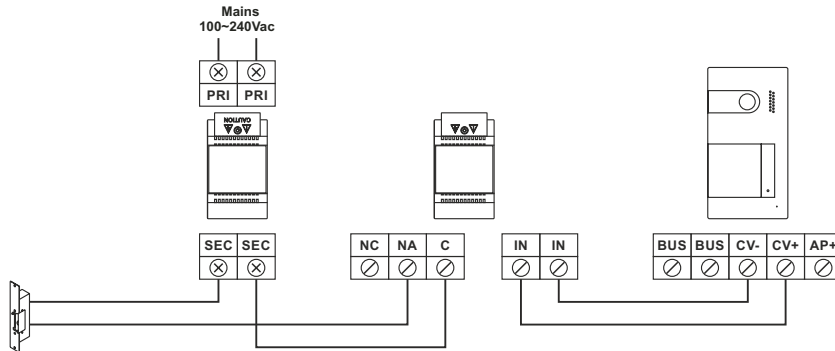

Relay output auxiliary device connection

The drawing shows, as an example, the connection of a second AC lock release. The relay can switch loads of 6A/24V. Activation is done through the  icon.

The activation time is 3 seconds, it being possible to adjust it between 0.5 and 10 seconds (see page 36).

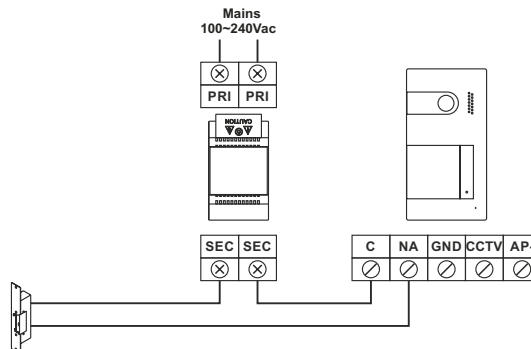

INSTALLATION DIAGRAMS

Exit button connection

The exit button allows the remote activation of the lock release connected between the CV- and CV + terminals (by default) or the relay output (see page 36). The delay time for activation is 3 seconds, it being possible to adjust it between 0.5 and 10 seconds (see page 36).

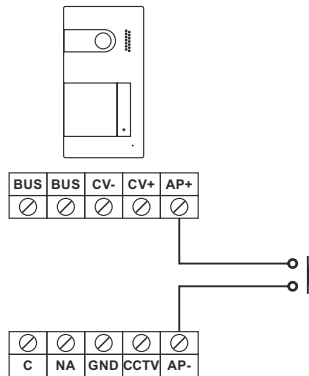

External CCTV camera connection

It is possible to connect an analog CCTV camera to each of the door panels, and they can be viewed (see page 35) from the monitor or the mobile application. The camera must have local power.

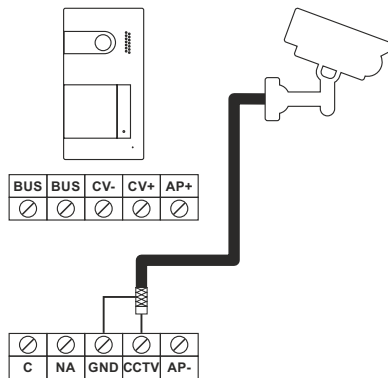

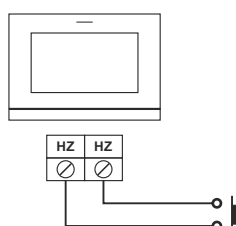

Doorbell push button connection

Connect the doorbell push button to the HZ inputs of the monitor you want to ring.



## SPECIAL CODES

The activation of some functions, as well as to modify some factory parameters, can be carried out by entering special codes. To do this you must access the installer menu from the monitor. Go to the "About" screen in the settings menu (page 15) and press five consecutive times on the  icon at the top right of the screen, appearing a keyboard for entering the codes.

The codes must be entered one by one, preceded by the asterisk symbol and validated by the  icon. If the code entered is valid, the message OK will be displayed; otherwise the message ERROR will be displayed.

When the parameter of a door panel is modified, it affects to all door panels. The parameters modified in one monitor do not affect the rest of the monitors.

Use  icon to return to the main menu.

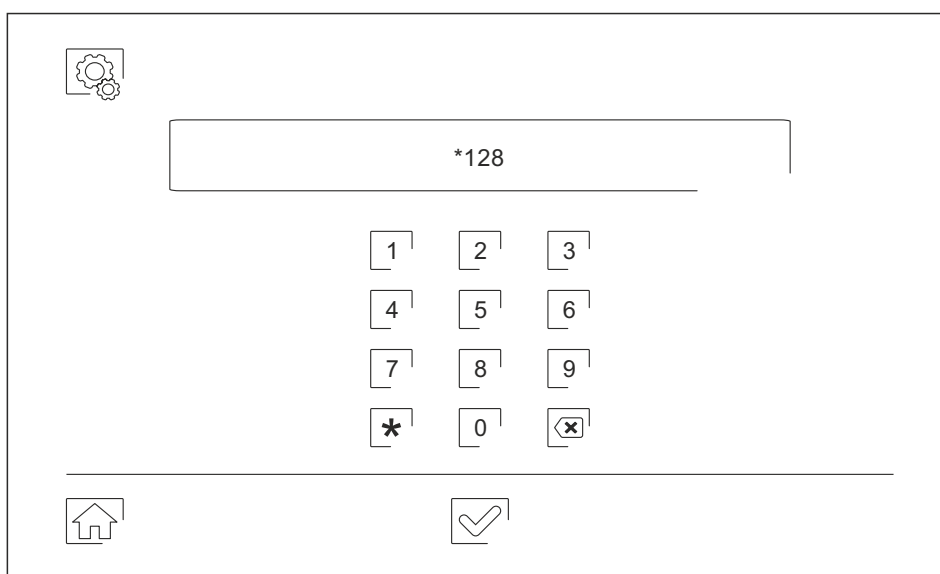

### Video sources available in the monitor.

	<u>Available</u>	<u>Not Available</u>	<u>Factory value</u>
Door panel 1	*111	*110	*111
Door panel 2	*121	*120	*120
Camera 1	*141	*140	*140
Camera 2	*181	*180	*180

### Automatic lock activation when a call is received on the monitor.

	<u>Enabled</u>	<u>Disabled</u>	<u>Factory value</u>
	*441	*440	*440

---

**SPECIAL CODES**

---

**Outputs activation time.**

		<u>Factory value</u>
Lock release	From *200 (0,5s) up to *219 (10s)	*203 (3s)
Relay	From *300 (0,5s) up to *319 (10s)	*303 (3s)

**Remote activation input configuration.**

		<u>Factory value</u>
Delay	From *400 (0,5s) up to *419 (10s)	*403 (3s)
Operating output	*430 (lock release) or *431 (relay)	*430 (lock release)

---

SOUL DOOR PANEL INSTALLATION TEMPLATE

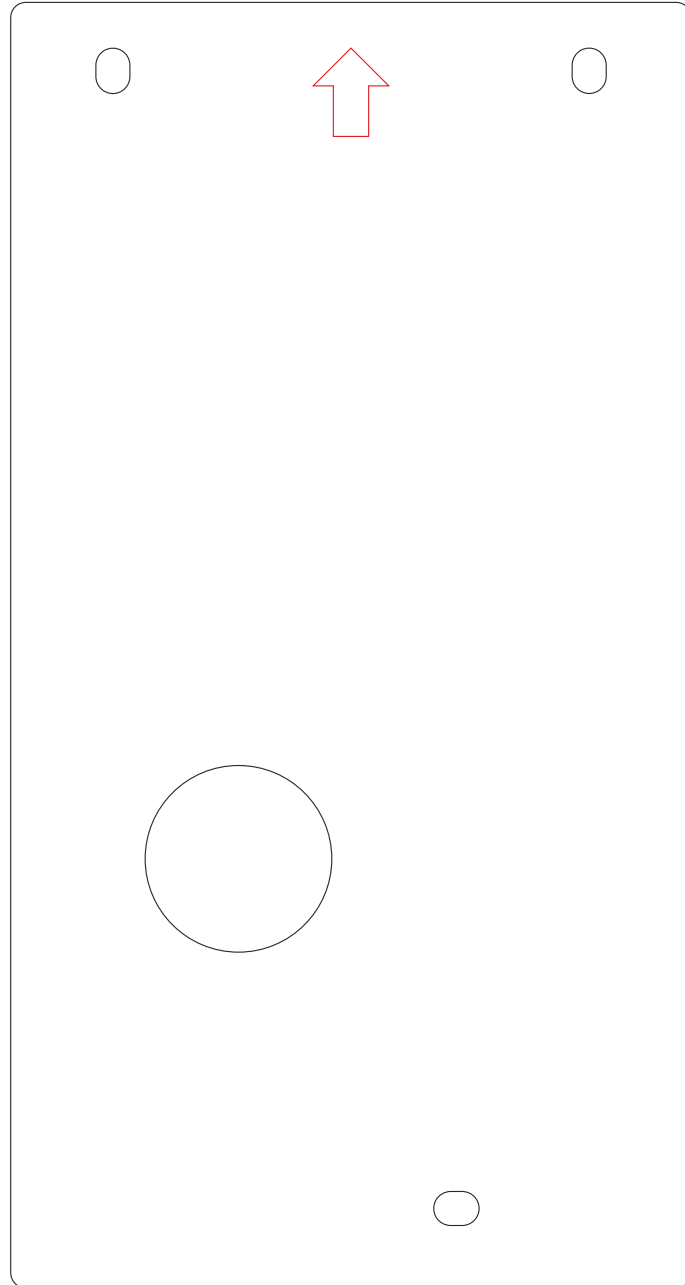

ART 7 MONITOR INSTALLATION TEMPLATE

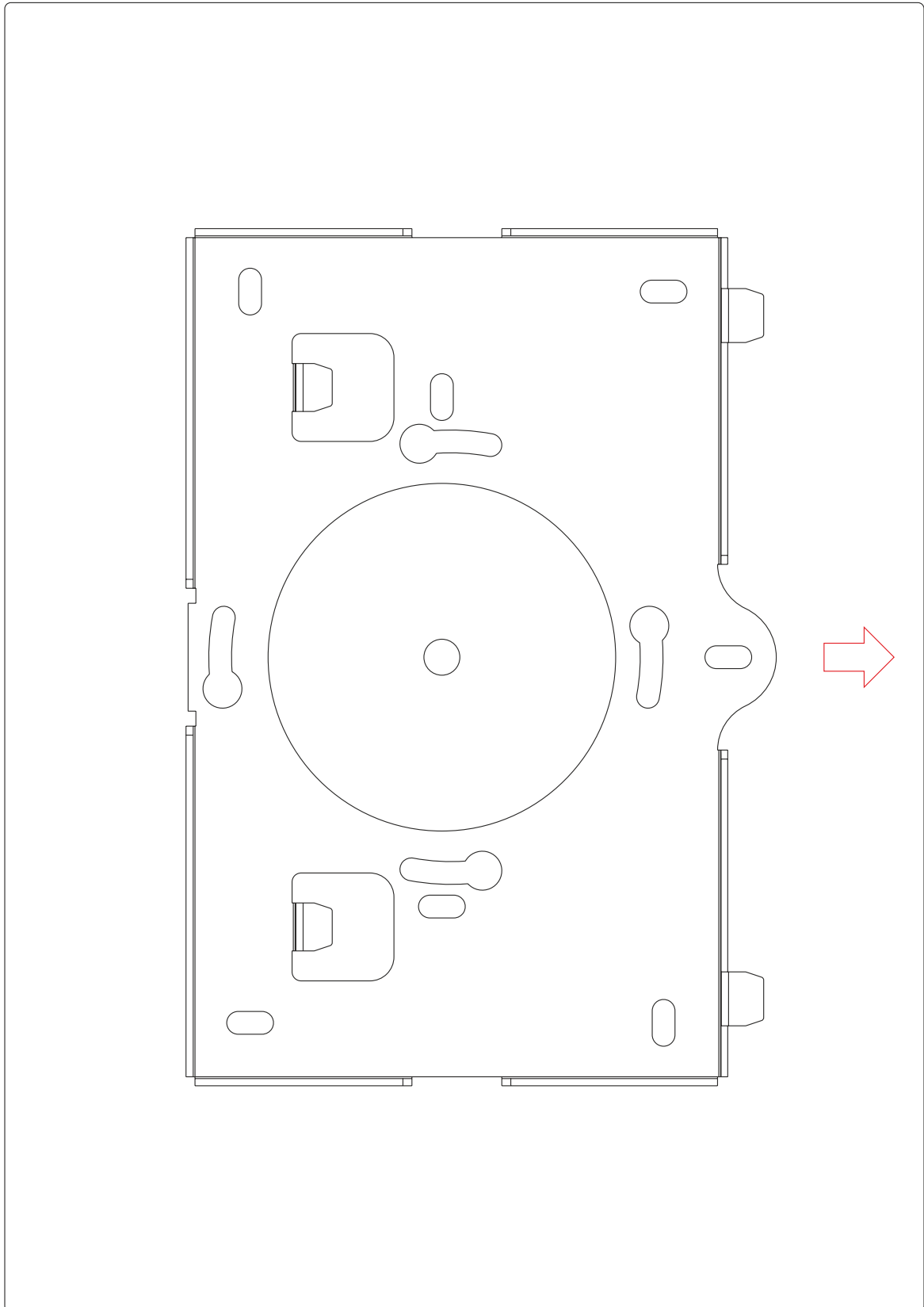





golmar@golmar.es  
www.golmar.es

---

GOLMAR S.A.  
C/ Silici, 13  
08940- Cornellá de Llobregat  
SPAIN



Golmar se reserva el derecho a cualquier modificación sin previo aviso.  
Golmar se réserve le droit de toute modification sans préavis.  
Golmar reserves the right to make any modifications without prior notice.